

Kit L-1

Logic INSTRUCTION MANUAL and WARRANTY



Kit L-1 includes:

- 1x **2008** Logic, logical mixing and main control hub
- 1x **2116** Rider's 8 ohm noise cancelling stereo headset
- 1x **2174** Standard 400mm phone lead
- 1x **2243** Standard 150mm stereo music lead

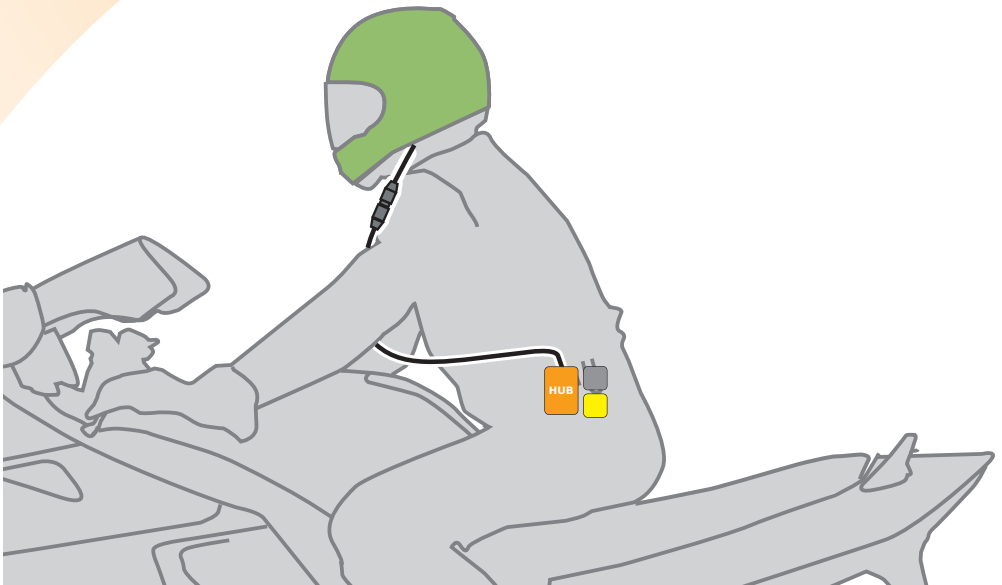

IMPORTANT NOTE:

PLEASE ASK your supplier to personally check with you that this kit contains ALL the parts listed above before you leave the shop!

Autocom UK has carefully checked that all of the parts listed above are supplied in this kit at the time of packing and shipping; however we also train our suppliers to check and confirm with you (in the shop) that you have all of these listed parts supplied in your kit before leaving the shop. Because of this thorough triple check quality control method Autocom UK cannot accept any claims for missing parts once you have left the shop.

This product is intended for sale ONLY from authorised retail premises by trained authorised Autocom dealers, where your supplier has provided you with high quality hands on demonstration and advice about the products before you purchase. This product is not to be sold/purchased via mail order etc or from any dealer who has not/or cannot provide you with high quality face to face hands on demonstration and after sales service and support.

If this product was supplied to you by mail order, we ask that you please contact enquiries@autocom.co.uk or telephone: +44 (0)1926 431249 and let us know who your supplier was, such that we can ensure that ALL of our customers receive the highest standards of supply and support that our customers, products and brand deserves.

Please fill in and return the product registration on the inside back cover.

It is **very important** that you fully read and understand all of these instructions before installation and use.

This system is designed for domestic motorcycle use only.

CONGRATULATIONS

Thank you for choosing Autocom. Your Logic system is designed, built and fully tested to be the very best, and provide you with many years of very high quality use and performance if installed and used as described in these instructions.

Please take the time to fully read and understand these instructions before installation and use and feel free to ask your Autocom dealer for advice, or call our help-line if anything is not perfectly clear and understandable. Telephone: +44 (0)1926 431249 (UK). Email: enquiries@autocom.co.uk

SAFETY FIRST

It is very important to properly set up and use these products as designed. Please do not make any modifications or try to use your system with any non recommended products or in any other way than described. Do not cut or modify your helmets.

It is common sense and the **law in some countries** that the rider of a vehicle be in control at all times, which includes the ability to hear other road users warnings. As **such the RIDER should not have the music volume so loud as to prevent this. Safety should always be your first priority and is ultimately the responsibility of the rider.** Make sure that the quick release connectors are free to quick release in the event of an emergency. Do not fix or tape them together.

The rider should only make adjustments while stationary, never while in motion. Always focus your attention to riding and safety and do not use the system in such a way as to interfere with this. The added ability to communicate between rider and passenger and/or with other riders on other bikes can considerably improve your safety, so become familiar with using the system to provide good advice and/or warnings etc.

OVERVIEW

The Logic system supplied as Kit L-1 is an expandable rider's portable audio/communications system and comes with a rider's 8 ohm stereo headset, plug-in true noise cancelling boom microphone, rugged water resistant headset leads and connectors, plus standard phone* and stereo music leads (note* some phones may require a personal hands free adaptor, available from most phone shops)

The innovative logical mixing and control design has 6 Aux connections to provide seamless integration with various optional audio devices such as; **bike to bike radio** (some of which can also be bike powered) **GPS** (including stereo GPS), two or more **phones** (including stereo phones) two or more **stereo music** devices and/or **radar detectors** etc, **simply by selecting the optional interface leads to suit your specific needs**, or by using the optional **single or twin plug-in stereo Bluetooth module/s** which can connect to between one and four wireless Bluetooth devices.

The Logic system is perfectly designed for portable use using 3 standard AA batteries, or rechargeable batteries, or you can use **your choice of bike power leads** for mile after mile of fuss free endless use, and/or add a **passenger headset** at any time if required, again all simply by selecting the optional parts to suit your specific needs, whenever you want it. **It is designed and sold this way to save you cost as to include all possible parts/options for every potential variation would not be practical or cost effective.** Your Autocom dealer should be able to help you choose what optional parts you may require.

PLEASE NOTE: setting up and using your Logic hub as a portable battery powered system is easy and straight forward, once you have used these instructions to help guide you through correct headset installation and use.

Bike mounting and powering your Logic hub (using optional bike power and headset extension leads) is also relatively straightforward, once you learn and understand some important basics.

These instructions have been designed to help guide you through helmet installation, setting up and using the system, plus the more in-depth understandings required for bike mounting and powering the system, just in case you later decide to bike mount and power your portable system, as many customers do.

Please note that if you are using 3 AA batteries to power your portable Logic hub, the battery power is automatically switched on when you connect a headset to either lead, and automatically switched off when both the headsets are disconnected from the hub.

The words throughout these instructions "turn the ignition on/off" or "start the bike" etc, relate to the portable instruction equivalent of "connect/disconnect the headset/s".

Autocom systems are track tested to over 180mph during development, where they are tuned to provide superior performance. Each part is fully tested before it leaves the UK factory and set such that most users will simply power, connect up and use straight out of the box without the need to make any adjustments.

Some people may need a little more time or extra help to get used to the system, in particular to the importance of correct microphone and speaker positioning, so please be patient and if in any doubt do not hesitate to ask for help. If your system is not performing as you would expect or as we claim it should, then the most likely cause is incorrect installation or use, in particular microphone and speaker positioning.

These instructions have been designed to try to help you get the most out of your system, but if it does not exceed your expectations then we want to help. You are welcome to visit our factory at anytime, Monday to Friday, 09.00 to 17.30 plus Saturdays by appointment. If you cannot get to our factory then please contact your dealer or Autocom distributor; details available on our website: www.autocom.co.uk

Autocom systems have been rated the very best for over 16 years, having won every credible media back to back test, and not just by a bit, but by miles. We hope you like this product and enjoy it for many years to come, as much as we have enjoyed designing and building it for you.

Tom Beman (MD)
Autocom Products Limited

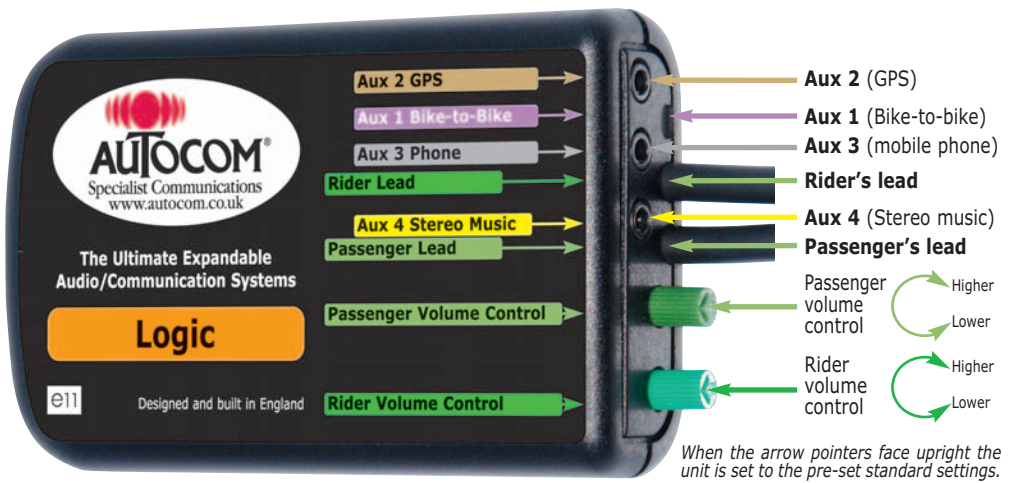

CONNECTIVITY • LOGICAL MIXING AND CONTROL

A range of optional accessories lets you personalise your expandable system.

Aux 1 • designed for Bike-to-Bike

Rider or passenger's speech automatically transmits the bike to bike radio, thanks to the VOX providing easy and safe hands free use. Incoming bike to bike on Aux 1 automatically reduces the audio on Aux 4 to 50% to improve speech clarity. When the phone is in use on Aux 3 it disables the bike to bike VOX transmit function so that your phone conversations are not broadcast out to the other bikes, which allows the other bikes to continue with communications while you are on the phone. If you bike power your hub you can also bike power recommended bike-to-bike radios, plus take advantage of the optional handlebar remote control, to disable the VOX transmit mode providing privacy for rider-to-passenger communications, and then transmit bike-to-bike messages at any time by either pressing the press-to-talk (PTT) button, or toggle back to the normal VOX transmit mode. When the phone is in use and disables the VOX transmit function, the remote control PTT button lets you over-ride this so that you can transmit to other bikes even when on the phone.

Aux 2 • designed for Stereo GPS

Incoming audio on Aux 2 automatically reduces the stereo music level on Aux 4 to 50% to improve audio clarity. Note; you can use some phones via some GPS units, but in most cases you lose the important GPS audio and safety camera warnings while using the phone through a GPS. This is why we provide separate GPS stereo connectivity and separate phone connectivity to manage this better for you.

Aux 3 • designed for Stereo Phone

A phone can be connected using the standard lead* supplied, or via the optional stereo Bluetooth interfaces. Incoming phone audio automatically cuts the stereo music on Aux 4 by 100% and reduces bike-to-bike audio on Aux 1 plus stereo GPS audio on Aux 2 to 50% to improve phone conversation; while at the same time it also disables the bike-to-bike VOX transmit mode to prevent your phone conversation been broadcast to other bikes.

*Some phones may require a hands free adaptor.

Aux 4 • designed for Stereo Music

Rider and passenger speech automatically reduce the stereo music on Aux 4 to 50%. It doesn't cut completely just in case you like to sing along. Audio from Aux 1 and 2 also reduces the stereo music by 50% to improve audio quality, while incoming audio on Aux 3 fully cuts the stereo music for improved phone conversations.

Aux 5 and Aux 6 for optional plug-in Single or Twin Stereo Bluetooth Module/s

Each of the stereo Bluetooth modules lets you connect wirelessly to one or two Bluetooth devices, so long as one is using hands free profile (such as a mobile phone or GPS, etc) and the other uses advanced audio profile (A2DP, such as stereo devices, mp3 players, etc). The twin Bluetooth module lets you connect to between 1 and 4 Bluetooth devices.

Each Bluetooth module can be independently set to have the same effects as incoming audio on either Aux 2 or 3.

Optional Passenger Headset

When either person speaks, the VOX system automatically turns the microphones on, reduces the stereo music and transmits the bike to bike radio, for safer hands free use. When you stop speaking the microphone/s automatically turn off and the music gently glides back to its normal level. High quality leads (and optional straight or coiled headset extension leads) are custom designed for easy, safe and comfortable use. Built to last but also easy to service or replace. Optional neat on-bike rubber socket holders with water resistant dust caps provide that professional finishing touch.

GETTING STARTED

Using your Logic as a portable battery powered system is straightforward and battery power automatically turns on when a headset is connected to either headset lead. The headset leads coming from the main control hub are long enough to connect directly to each helmet. To install 3 AA batteries simply remove the battery cover by depressing the catch release circle on the battery cover and sliding the cover downwards. Take care to install the batteries correctly noting the positive and negative orientation markings on the battery tray. To protect the control hub we have provided reverse polarity protection just in case you incorrectly fit the batteries, in which case the system simply will not work. Please remove the batteries if not using the system for more than a few days.

If bike powering your Logic (as many customers do) the power lead will connect to the white 9 pin connector in the battery compartment and exit through the small breakaway plastic tongue in the bottom of the control box. Picture **A** allowing you to replace the battery cover.



Before fully installing the Logic main control hub on your bike (or in a tank bag etc), carefully think it through. There are many ways in which you can install your system but there is usually only one way which is best for you and/or your bike. It is easy to get carried away and do a complete installation only to then find problems at the end and not know the cause or how to resolve them. If you follow these instructions carefully you should avoid (or find and cure) any problems during the installation, meaning you only need to do it once.

Top Tips (1)

The Logic main control hub is splash resistant; it is **designed NOT to be completely sealed so as to allow it to breathe**. It is however reasonably protected from damp and the odd splash, so please consider its location carefully in order to help prevent excessive water contamination. For example, **do not position it where water will be forced in under pressure, such as in the front of the bikes faring, or under a wheel arch etc**. Look for locations, such as under the seat or in a tank bag/pocket or wherever you are sure it will not get soaking wet. **Reasonable care should also be taken when washing the bike, especially if using a jet wash**. If you cover the control box with a bag when washing, remove the bag afterwards to ensure the unit can breathe or you may cause damage if it is allowed to build up excessive condensation. If you do not feel you can position the main control unit where it will not get excessively wet, please ask your dealer about the optional water protector cover.

TRIAL FIT AND CHECK THE MAIN CONTROL HUB UNIT

Position the main control hub where you think you would prefer it to go, then trial fit the power and headset leads, plus any other audio interface leads (and audio devices) to make sure they will all reach and connect together, and adjust as required. Avoid stretching any cables to their limits to avoid stressing the connections, always leaving some slack.

Top Tips (2)

Think about cable lengths and where they will run, trying to avoid any sharp edges or seat pressure points/catches where cables may get trapped or crushed, and areas of potential electrical interference such as spark plugs and HT lead/coils, and the voltage regulator (normally a metal finned box bolted to the bikes frame) and areas of high heat such as engine and exhaust systems. Check with your dealer or our website www.autocom.co.uk for any specific bike installation tips.

Mounting the main control hub under the seat (as most people do) is normally near the rear light cluster in the tail unit and fixed down with Velcro to stop it sliding about (but also making it easy to remove for access if required) **(B)** The riders lead (longest) will typically come along the bikes frame under the seat and exit between the seat and tank (between the riders legs) **(C)**. If required you can use an optional straight headset extension lead so that it will reach under the tank and then come out near to the front of the tank/headstock area. The rider will use an optional straight or coiled headset extension lead to connect between the riders headset and the bike mounted socket (providing two safety release points in case of an emergency or should you ever forget to unplug when leaving the bike). The passenger lead will normally exit near to the rear of the seat, (often close to the passenger grab handle where fitted) **(D)** and use an optional straight or coiled headset extension lead between the headset and bike mounted socket.



If fitting the **optional on-bike rubber socket storage holders**, ensure all surfaces are flat, clean, dry and free from grease and wax etc. **PLEASE NOTE; the socket holders are designed to keep the sockets tidy and dry when not riding. Always remove the sockets from the holder before use.** For SAFETY reasons the rubber holders are purposely designed to tear off if pulled so that the connectors will ALWAYS separate in a straight line in an emergency.



Mounting the main control hub in a tank bag, using one of the optional two part bike power leads with in-line connectors, (E) the riders lead will easily reach directly from the hub in the tank-bag to the rider's headset, without needing to use an optional headset extension lead. The passenger's headset will connect via an optional straight or coiled extension lead directly to the main hub's passenger lead, with it just hanging out of the tank bag. Or you may prefer to use an optional long straight headset extension lead that connects to the hubs passenger's lead (hanging just outside of the front of the tank bag, near the headstock, next to the power lead connector) which runs under the bikes tank and seat and then exits by the rear of the seat (near to the grab handle where fitted) so that the passenger can use an optional straight or coiled headset lead to connect from their helmet to their on-bike socket. Please ask your dealer about optional headset extension leads and various two part power leads that are available if required.



When you have checked and concluded where you want to mount the main control hub, including running both headset leads, power lead and any audio leads etc, you can now connect the power lead to the bike and test/move if required before finally using some Velcro and tie-wraps to fix in place.

Top Tips (3)

Where you route the cables along the frame of the bike etc, secure them as required using tie wraps. **Care should be taken to ensure that the cables cannot fall into the chain, wheel or foul the steering etc, or be trapped or crushed by the seat or body panels.** If required use some hard packing strips either side of the cables to prevent damaging the cables at pressure points such as where the cables come from under the seat between the tank and body panels etc, if required bond the packing strips in place but only after you are sure of the final location. Avoid any sharp angles or edges, which may damage or cut the cables.

Pay particular attention to the seat locking mechanism, which, if fouled could cause problems with removing the seat. When using tie wraps please be careful not to over tighten them, **taking extra care to avoid brake-lines, breathers, overflow pipes etc.** and when you cut the surplus off any tie wraps remember to cut it short and square so that it reduces any sharp edges that may scratch you when servicing or washing the bike.

CONNECTING THE OPTIONAL POWER LEAD TO THE BIKE

WARNING; extreme caution must be used when working with bike batteries, due to the very high current capacity of the battery, which if shorted; between the battery terminals, or between the battery positive terminal and ground (the bike frame etc.) there is a very high risk burns, fire or explosion. Please check your bikes instruction manual before working on the battery.

Always connect the **BLACK (negative)** wire directly to the battery negative terminal using the crimped eyelet supplied, as this is the best earth on the bike. **Not using the battery earth/NEGATIVE is the most likely cause for electrical interference issues.**

Connect the **RED (Positive)** wire to a recommended, **switched ignition fused supply (5 amps maximum, unless you fit an additional in-line fuse of between 3 and 5 amps).** Ask your bike supplier if they know of any recommended accessory power points on the bike, or consult your bikes handbook, but only use this for the positive supply.

Typical places to find an **ignition switched fused supply** are the **positive feed to the tail lights, or rear brake light switch.** Ask your bike dealer if you are not completely sure. Please note that you can split the red and black power cable as required and cut them to length but don't do this until you make the final installation/connection, remember that you may need to move the system to a better location to avoid electrical noise after testing, or perhaps someday onto another bike, so leave plenty of spare power lead neatly coiled up and secured with a tie-wrap so that it can never fall onto the exhaust or back wheel/chain etc. **Do not connect to the brake light circuit if your bike has ABS braking and/or a brake light failure warning system** (consult your bike supplier/ manufacturer for approval before connecting to any ABS brake light circuit or bikes that have CANbus). If connection to the brake light supply circuit or rear tail light is not recommended, please use some other recommended fused/ignition switched 12 volt supply. **Always solder** the positive joint wherever possible as this provides a more professional and reliable connection. **Do not use quick connectors like scotch-locks etc. These are nearly always unreliable and most bike manufacturers condemn their use, which may also affect the bikes warranty.** You will notice the supplied fitting kit includes items which will assist in installation e.g. tie wraps, insulation amalgamating tape to cover the soldered positive joint, (again don't use this for the pre-install test) a crimp type eyelet for connection to battery negative terminal, Velcro to fix the control box and if required also speakers into helmet. For added safety and protection the system has reverse polarity protection, which means that it reduces the risk of damage if you accidentally wire the power lead the wrong way around, however, the hub will not function unless wired correctly. The system also has short circuit and thermal overload protection, which means the hub will automatically shut down in the event of being overloaded e.g. incorrect transceiver used or improper connections.

Ask your dealer about optional Part 2437 which can help solve problems if you suffer from electrical noise.

TEST THE PRE-INSTALLATION FOR ANY ELECTRICAL NOISE, AND MOVE PARTS IF REQUIRED BEFORE FIXING

Connect a headset speaker harness (via an optional headset extension lead if bike mounting the system) to the riders lead on the main control hub (longest lead) also connect the optional passengers headset (if being used) again via another optional extension lead if bike mounting the system, to the passengers lead on the main control hub. **DO NOT CONNECT** the boom microphone/s just yet, or any other audio interface leads to the main control hub.

Set the rider and passenger master volume controls so that the pointers on the end of each control knob point to the central positions as marked on the label). (Picture **A**).

Open the battery compartment and set the small VOX pre-set control per the illustration (**B**).

Start the bike in a well ventilated area, after checking that no parts will fall off onto a hot exhaust etc. Hold the rider's headset speakers firmly and directly over both ear holes (noting the centre of each speaker is slightly offset in the plastic housings) and listen carefully for any electrical interference through the speakers. HT (sparkplug/leads and coils etc) may induce a rapid tick, tick, tick noise which changes with engine RPM. Alternator noise if heard is normally a higher frequency constant whine, which again changes with engine RPM, so try to vary the engine RPM while listening carefully through the speakers for any induced electrical noise. It should be completely clean and in which case you can now turn the rider's volume control fully clockwise (FULL VOLUME) and do the same test again, it should be completely clean. Now do the same tests using the passenger headset to again prove it is complete clear of any electrical interference. It is very unlikely that you will hear any electrical interference while doing these tests, but if you do you should carefully move the lead/s about, one at a time, and/or the main control hub, while still listening to the speakers with the engine running at varying RPM to identify which part is picking up the noise and then move it to a clean noise free location.

When you have done this and are happy with the location of the main control hub, headset leads and power leads etc, you can turn the ignition off and Velcro the main control hub into place, tie-wrap the headset leads and power lead neatly in place, double checking to avoid any problems/areas as mentioned in Top Tips (1, 2 and 3).

Fit optional on-bike rubber socket storage holders and clip the sockets into them.

UNDERSTANDING AND TESTING THE HEADSETS BEFORE HELMET INSTALLATION

We strongly recommend that you test your headsets out of the helmet (before installation) to make it easier for you to experience how even small movements in microphone and speaker positioning can considerably reduce or improve the sound quality and ease of use. With this knowledge you will have a benchmark to work to during final helmet installation later and be sure you are getting the very best out of your system. **Do not use earplugs during this test as they will hide and/or disguise much of what we are trying to listen for.**

Avoid pressure directly to the front or back covers of the microphones as this could cause damage. The microphone is floating in an acoustically dampening material to help prevent any helmet vibration being transmitted through the boom to the microphone as part of the noise cancelling measures. To move or adjust the microphone please hold it by the outer edges or rubber neck, making sure that the **beige side of the fabric sits flat against and central to your lips.** Try to avoid the microphone covers touching the Velcro on the back of the speakers.

Set both the rider and passenger master volume controls anti-clockwise (per picture **C**) and set the VOX preset control (in the battery compartment) as shown in picture **D**.

WARNING; because the system is capable of being **VERY LOUD** for use with earplugs **CAUTION** should be used when turning the volume control clockwise above the mid-way position unless you are using conventional earplugs.

Connect a boom microphone to the headset loom, noting the red connector will only connect together if aligned the right way round, making sure that it clicks right in.

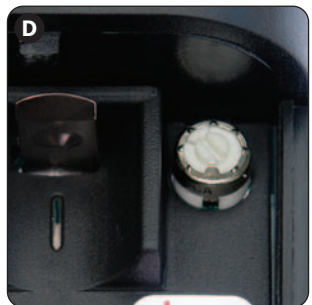
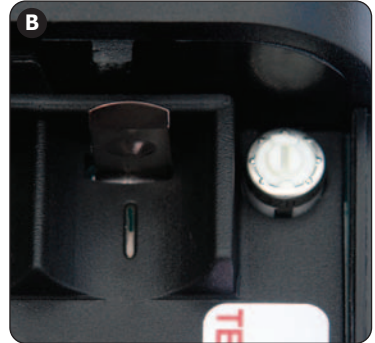

MICROPHONE LOUD SPOT POSITIONING AND USE

The microphone has a **critical loud-spot** which is the point where it produces the maximum energy from your speech into the system with the least amount of effort. The system has been carefully designed and tuned around using the loud-spot (as part of its superior noise cancellation design) so **it is important that you understand and use this loud-spot correctly.**

Turn the ignition on. If using a passenger headset get your passenger to hold one of the passenger headset speakers over their ear, so that they can monitor and learn what you are experiencing.

While holding one of the riders headset speakers over your own ear, place the **BEIGE SIDE of your microphone AGAINST YOUR LIPS** and without shouting, project your voice positively through it, as if to someone 5 meters (16') away. Try gently moving the microphone around (with it still touching your lips) while making a continuous positive tone noise to find the microphone **LOUD SPOT** (the loudest point).

You will know when you have found and used the microphone loud spot because your voice will reliably activate your VOX, and you know when you have reliably activated your VOX because the system has **SIDE-TONE** which amplifies your own voice through your own speakers, but only when activating your VOX, thus providing you with audio confirmation of correct microphone and VOX use. Remember; if you can hear your own voice amplified through your own speakers then you are operating your VOX and so you know that others will be hearing what you hear.

The side-tone not only provides you with important audio confirmation of correct VOX and microphone loud-spot use, but also lets you hear how loud you are speaking relative to helmet noise, and so helps you to naturally speak at a relevant level according to varying noise conditions, which prevents unnecessary shouting.

It is important that you do NOT set your master volume control any higher than actually required (too far clockwise) because if the level of your own voice amplified to you own speakers is too loud, it makes you want to speak at a lower level, which may not be enough to operate the VOX properly.

Setting your master volume control to an adequate level (that's not any higher than required) makes using the system much easier and more reliable, plus saves battery power. If you need to alter any other audio input levels then this should be done using the audio devices own volume control, and not by using the master volume controls. After setting everything up only use the master volume controls to compensate for using earplugs, monitor ear plugs or no earplugs.

If you are now comfortable with finding and using the microphone loud spot and operating the VOX reliably, let your passenger try this and become used to it, **then turn the ignition off** while we now help you experience the importance of speaker positioning.

Top Tips (4)

Fine tune and perfect using the microphone loud-spot by listening to the sound of your voice through the speakers while carefully moving the microphone around until it is at its very loudest point. Notice how it can help if you pucker your lips to the microphone as if kissing it, while speaking. After a short while this all becomes natural, especially when riding the bike in more noisy conditions.

You must speak into the beige side of the microphone

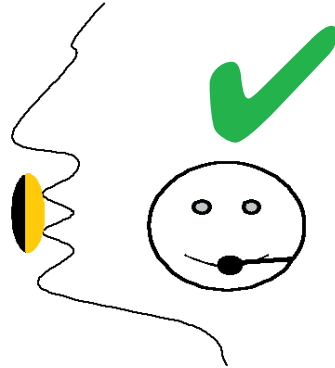

CORRECT MICROPHONE POSITION



INCORRECT MICROPHONE POSITION

SPEAKER POSITIONING

Ideally you want to play one of your most favourite pieces of music through the system that has rich sounds and plenty of bass, being something you can identify with later when testing the helmet installation.

Please check to ensure that both rider and passenger master volume controls are still set per picture **C** on **page 6**.

WARNING; because the system is capable of being **VERY LOUD** for use with earplugs **CAUTION** should be used when turning the volume control clockwise above the mid-way position unless you are using conventional earplugs.

Plug the 3 pole end of the stereo music lead (supplied in the kit) into your portable music devices headset socket and connect the 4 pole end into Aux 4 socket of your hub.

Top Tips (5)

Note: there are two audio leads supplied in Kit L-1, the longest lead has a smaller 3 pole plug one end for the phone* and a larger 4 pole plug the other end to connect to Aux 3, while the stereo music lead is the shortest lead and has the same size larger plugs to both ends, however one end has 4 poles to connect to your Logic hub (Aux 4) and the 3 pole end is to connect to a PORTABLE music device. **If both your Logic and music device are bike powered you MUST use an ISOLATION interface lead. See page 17.**

Make sure that you plug your music lead into the music systems headset socket and not the line out socket, or the volume control may not work.

Turn the ignition on. Adjust the music devices volume control to about half way and then press play, (note you need to wait about 10 to 15 seconds after turning the Logic power on before the music will be heard) **Before holding the speakers directly and firmly over your ears** listen to check that the music is not too loud and adjust as required using the music devices volume control.

Note that the speakers are slightly off-set in their housings so try to align the centre of the speakers directly with centre of your ear-holes (with the wire coming out towards the back of your head). Apply light pressure to the back of the speakers and you should now hear the music very clearly.

Now try to generate as much background noise as you possibly can, either by revving the bikes engine or using a loud TV, hi-fi system or perhaps a noisy vacuum cleaner etc, or even all of them together, as this ambient noise will simulate helmet noise as if riding.

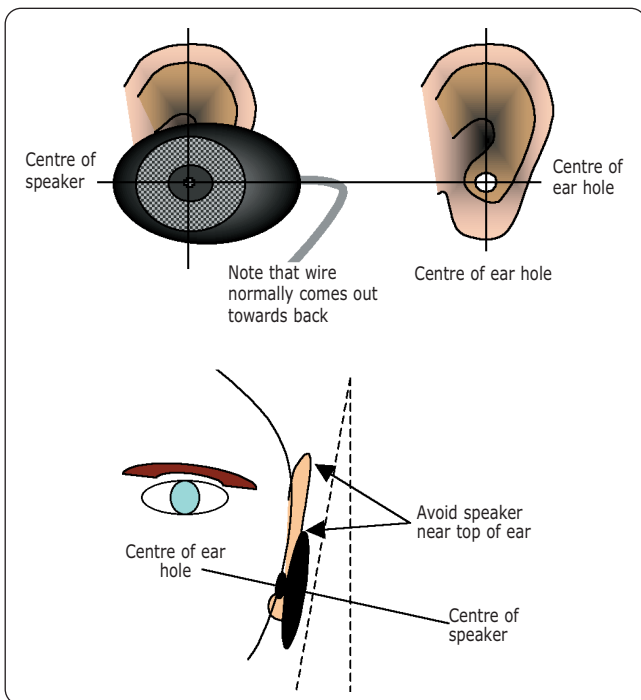

Listen to the speakers again with them correctly positioned over your ears and you should hear the music clearly with virtually no outside noise being heard. This is the ideal speaker positioning and you will notice that moving the speakers just a small amount away from your ears, or out of alignment (up, down, backwards or forwards) can easily half the volume and reduce the sound quality, in particular the bass response, and let considerable external background noise in which will spoil the full potential of sound quality and performance, especially at higher background noise levels (higher speeds), or when using earplugs.

When you have readjusted the speaker positioning, lightly pressed comfortably over your ears, so that the music quality is at its very best and you can hear the least amount of background noise coming through, **you have found the best possible speaker positioning** and so you now know what to aim for when fine tuning the speaker positioning after helmet installation.

If you now hold the BEIGE side of the microphone to your lips and project your voice positively through the loud spot, the VOX turns your microphone on while at the same time automatically reducing the music level to about 50% to improve communications. When you stop speaking the microphones automatically switch off and the music gently returns to its original level. Practice this a few times to become familiar with it, and show your passenger what you have discovered.

Turn the engine off.

Top Tips (6)

If your VOX accidentally turns on when you are not speaking due to high noise levels, please slightly adjust the VOX preset control clockwise until the noise no longer activates the VOX, but be careful not to turn it clockwise any more that is required or you will make it harder to operate with your voice.

It's sometimes a bit tricky holding three parts with only two hands so try pressing one ear to your shoulder with the speaker in between, leaving your hands free for the other speaker and boom microphone, or get someone to assist with holding the microphone for you.

HEADSET INSTALLATION

Because Autocom systems work so much better than other brands, it is easy for people to think its working great even when it's not set up and used properly and only giving you perhaps 30% of what is really has to offer. This is why we recommend that you to test the headset out of the helmet with some music, so that after installation you can hear if it sounds right and adjust as required. Using music is the best way of hearing this, even if you do not intend using music in future. If you have an optional passenger headset you can install and adjust the riders helmet first, and then check the installation against the other headset (out of the helmet) held properly in place.

The plug-in boom microphone/s supplied in the kit is our most universal boom designed to fit most full face, flip front and open face helmets, but please note; most open face and enduro/motor-cross style helmets, including flip-front helmets if you want to ride with it open, will require the optional open face conversion kit (Part 2156) to prevent excessive direct wind blast getting to the microphone. The headset is not designed to work with ½ helmets (Chip style) which normally require a much longer boom and perhaps some additional padding to mount the speakers over your ears. Replacement consumable microphone coverings (Part 2166) and replacement consumable foam speaker covers (Part 2155) are available from your dealer. The optional long boom microphone (Part 2075) is similar to our standard boom microphone but is 35mm (1½") longer and is ideal for larger open face helmets.

There are far too many different helmet types available to be able to fully describe every possible installation here, and one must also consider that each year various helmet designs change, so these instructions are designed as a basic guide only. Please see your local Autocom dealer or visit our website www.autocom.co.uk for more detailed specific helmet installations. Most authorised Autocom dealers are experienced with helmet fitting.

Please note; helmets that have straps that go directly over your ears may not lend themselves for a good headset installation, as the speakers have to sit either on top or behind the straps, which can make them uncomfortable or out of position which will reduce the sound quality. This is beyond our control and if our speakers do not fit then nor will any others. It is a good idea to remember this next time you choose a helmet. You can overcome this problem by using optional in-ear speaker plugs that can replace the standard over the ear type speakers. Consider optional Part 2091 which allows you to use most types of monitor (in-ear speaker plugs) with your system.

Some helmets may not lend themselves to be installed as we have suggested and so may require alternative methods. Please take plenty of time to carefully consider all these basic principles, together with the installation diagrams and your own helmet design to see if you can establish any similarities that may help you with installation. If you are unsure about any of the above then please contact your supplier or Autocom for help and advice. **DO NOT CUT YOUR HELMET!**

Put the helmet on and try to work out exactly where the centre of each ear hole is relative to the straps or any seams etc in the lining, and also while doing this try to find and mark the exact location of the centre of your lips inside the chin pad with the helmet sat in its natural position.

When you have established these positions within the helmet you are then ready to start the headset installation/s.

Top Tips (7)

When installing the headset into the helmet **place the helmet on a soft towel** etc, so as to help stop it sliding about and/or getting scratched. You may notice that most people's ear holes are between 25mm (1") and 32mm (1½") below the top of their ears, and that most people's top of their ears are about in-line with their eyebrows. If you look at someone's face through the helmets visor area, you can reference their eyebrow position to the helmet and then assist them with working out the approximate position below this for their ear holes. If they can then also feel and then reference the approximate horizontal position of their ear holes relative to the straps etc, it will provide a good starting point for speaker positioning, but always start with the speakers low for maximum comfort and then slowly lift them up until you obtain the maximum sound quality.



Example of an open face helmet



Example of a full face helmet

BASIC PRINCIPLE HOW HELMETS ARE ASSEMBLED

There are two main types of typical full face helmet designs, one is a one part chin and cheek pad design, per the illustration at the bottom of this page, the other and more popular type is a three part chin/cheek pad design, per the illustration below. Most full face helmets do not have the cheek pads glued in and are just a compression fit, which makes them much easier to remove (although some are quite tight).

For more details of open face or flip front helmets please see our website www.autocom.co.uk

Three Part Inner Helmet Design

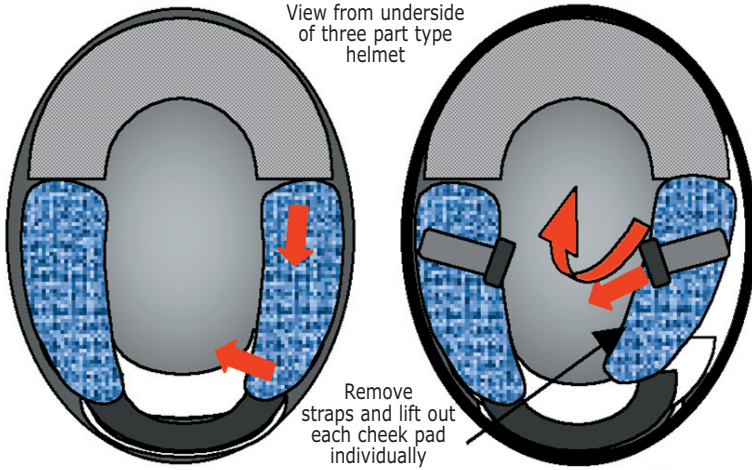

The fabric is either taped, glued or elasticated over the foam/polystyrene and so it is easy to install the speakers behind the lining. Note that the wire should come out of the speaker towards the back of the helmet.

Before replacing the cheek pads, tape the boom and the headset loom to the outer shell or the back side of the cheek pad. When the cheek pad is fitted back into the helmet, it will secure the boom and loom inside the helmet.

Do not modify the helmet.

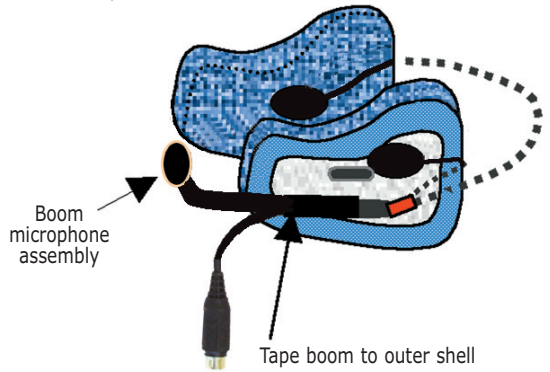

One Part Inner Helmet Design

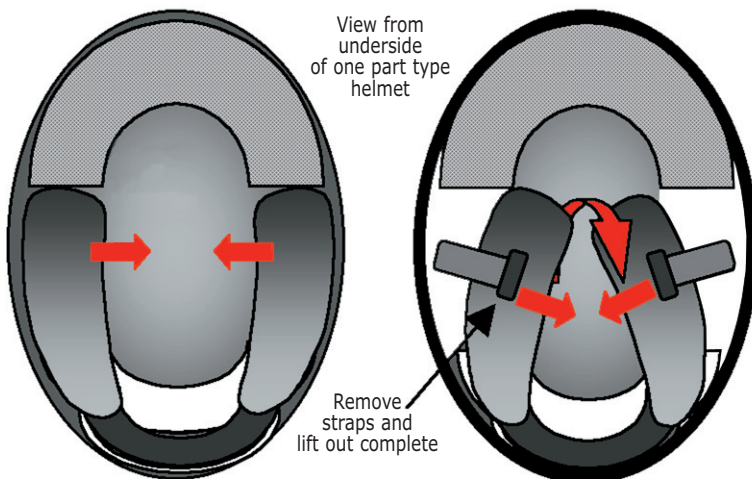

The fabric is either taped, glued or elasticated over the foam/polystyrene and so it is easy to install the speakers behind the lining. Note that the wire should come out of the speaker towards the back of the helmet.

Before replacing the cheek pads, tape the boom and the headset loom to the outer shell or the back side of the cheek pad. When the cheek pad is fitted back into the helmet, it will secure the boom and loom inside the helmet.

Do not modify the helmet.

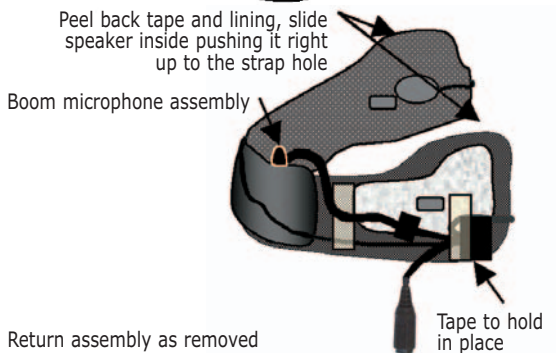

MICROPHONE INSTALLATION

Decide which side of the helmet you would prefer the lead and plug to hang from (normally the left side) and then release and remove that side's cheek pad so as to allow you fit the boom microphone and main speaker harness behind it, with the boom coming up from behind the cheek pad area, up into the visor area and then bent down (from between the outer shell and back of the cheek pad area) in front of your mouth.

Remember you must position the microphone so that you speak into the beige side, so orientate the boom, before fixing it to the outer shell of the helmet, so that when you bend it down (over) to sit in front of your lips, you will have the beige side touching your lips.

If required fix the boom and also the main harness down lead to the inside of the outer shell of the helmet using some of the Velcro supplied in the kit, which is usually very good for this purpose so long as where applied is completely clean and dry (**A**).

While the cheek pad is removed you can see if the fabric is taped, glued or preferably elasticated behind it.



Picture showing loom and boom assembly within a full face helmet.

Top Tips (8)

Avoid crossing any wires with another or with the boom as this will create a higher than necessary spot which may make it difficult to replace the cheek pad.

If your helmet has an air vent in the chin-bar (in front of your mouth) it is a good idea to cover and seal this from the inside of the chin-bar so that the wind is not able to blast directly onto the back of the microphone. This also helps to force more of the airflow up into the visor area which can often make demisting the visor more effective for you.

With the microphone positioned close to your mouth, you may notice that it just clips your nose when putting the helmet on and off. You can avoid this by learning a technique of slightly twisting the helmet so that the boom clears your nose while putting the helmet on or off.

If your wires and/or boom microphone make replacing the cheek pad difficult **DO NOT CUT the polystyrene**. You will normally find that only a VERY SMALL amount of extra space, or better positioning, would remove all the pressure and so allow the cheek pad to fit.

Only if you have tried everything else first, including asking your dealer for advice and/or help first, should you use your thumb (or something harder, smooth and rounded like the back of a small screwdriver handle) to carefully compress **JUST ENOUGH** of the polystyrene for the wire/boom to slightly recess into it, to help relieve any pressure points. This would NOT normally require more than just 1 or 2 mm ($\frac{1}{16}$ ") in an area no larger than required.

SPEAKER INSTALLATION

Most helmets have ear pockets (indentations) designed into the lining to let your ears fold back after they are folded over while putting the helmet on. Sometimes the fabric covering these ear pockets is glued back to the polystyrene cheek pad, forming a visible pocket. Other times the fabric is just stretched over the foam pocket and is not glued back.



If the helmet has deep pockets and the fabric is glued back you may need to fit some padding behind the speakers (like our optional foam speaker pads Part 2159 which are about 6mm or ¼" and/or Part 2160 which are about 12mm or ½"). These foam speaker pads have Velcro fitted so that you can fix the speakers to them. **Always start without any padding and with the speakers set deliberately low, then test for comfort/sound quality. Then pack out and/or adjust up to the correct positioning over your ear hole, thus avoiding having the speaker too high or tight where it may cause excessive pressure to the top part of your ears.**



If the fabric is not glued back forming a visible pocket then while it is easier to just Velcro the speakers on top of the loose fabric (which can sometimes work quite well in some helmets) it is far more likely to cause your ears to fold over when putting the helmet on, so most people prefer a more professional installation where the speakers are set behind the fabric but on top of the foam/polystyrene behind. **If you have time and can install the speakers behind the fabric, it makes for a much more professional semi permanent fitment, which is normally much more comfortable** and this is how we would normally try to install the headset/s for you if you brought them to us.

In order to be able to place the speakers behind the fabric you normally need to remove the cheek pads from the helmet to reveal the back where the fabric is glued, taped or preferably just elasticated over the polystyrene. **Carefully peel the fabric back** enough to slide the speakers into place (normally about level or just below the level of the hole for the strap and just behind the strap). Try to copy the illustrations on pages 9 and 10. Again it is important to start with the speakers set deliberately lower to help with maximum comfort and avoid pinching the top part of your ears, and then adjust them upwards as required to obtain the best sound level and quality. If you have to un-gluce or un-tape the fabric, masking tape is often used to stick this back down

Please see illustration on page 8 and note that by angling the speakers as shown it helps to ensure even pressure between the speakers and your ears, thus improving both comfort and sound quality. The speaker wire normally exits the speaker towards the back of the helmet.

DO NOT CUT the polystyrene. You will normally find that only a VERY SMALL amount of extra space, or better positioning, would remove all the pressure and so allow the cheek pad to fit. **Only if you have tried everything else first** should you use your thumb (or use something harder, smooth and rounded like the back of a small screwdriver handle) to carefully compress **JUST ENOUGH** of the polystyrene, for the back of the speaker to slightly recess into the polystyrene, This would NOT normally require more than just 1 or 2 mm (¼") in an area no larger than the back of the speaker magnet.

Top Tips (9)

If your cheek pad has a plastic tongue to hold it in place, be careful not to break this off when removing or replacing the cheek pads, and also be careful not to trap or cut the speaker wire/s with it when replacing the cheek pads. When you have installed the headset you can use the back of a toothbrush handle to make a great tool for carefully pushing any wires up into the lining and around the back of the neck draft excluder. You may find it is better to fix the speakers with Velcro so as to help avoid them slipping up inside the helmet which can happen over time due to movement when putting the helmet on. **For the first time putting the helmet on after installation it is often beneficial to use something like a silk balaclava to help prevent your ears being folded over while putting the helmet on and off until you have fine tuned the speaker positioning for maximum comfort and performance. If for example your right ear is folded over after putting the helmet on you should immediately use your right hand to pull the right hand strap so that you can get your left hand fingers up into the right hand side of the helmet to flick your right ear back straight etc.** while doing this you may also be able to feel the speaker position in relation to your ear and if possible try to move the speaker for a better fit/sound.

Please visit our website: www.autocom.co.uk for further helmet fitting instructions.

TESTING THE INSTALLATION AND FINE TUNING THE SPEAKERS AND MICROPHONE POSITIONING

Put the helmet on and play preferably the same piece of music that you listened to earlier, and try to focus on one speaker/side at a time, while moving the helmet up, down, backwards and forwards and also side to side to listen for any improvements or loss of sound level and quality.

If for example, moving the helmet forwards (on one side) improves the sound level or quality for that speaker, it means your speaker is set too far back, so readjust it forwards, and keep fine tuning the position until any movement forwards or backwards only reduces the sound quality/level and does not improve it, meaning that you have found the best horizontal position for that speaker. Do the same for the other side and then test for up and down.

If for example, moving the helmet up (on one side) improves sound level or quality for that speaker, it means the speaker is set too low, so adjust the speaker upwards, and do this accordingly with each speaker/side until you are happy that you have the best possible vertical and horizontal positioning for each speaker.

If you now push the side of the helmet towards your head and notice improved sound, it means you need to pack that speaker out on some foam so that it is nearer to your ear. Do this to both sides, and then recheck each side for vertical (up, down) alignment and also again for horizontal (back and forwards) and adjust each speaker until it cannot be improved.

Ensure the sound is equally balance to both ears, if it is slightly louder or has more bass in one ear it means the other speaker is out of alignment (or need more packing out) until the sound from both speakers are equal.

Needless to say you will need to find the best compromise in both comfort and sound quality/level, and your comfort will almost certainly be your top priority, however please remember that angling the speakers as show in the diagram on page 8, and avoiding the top part of your ears will greatly help to improve both positioning/sound level and quality while maintaining maximum comfort.

It may take a little extra time now to get each speaker correctly positioned and fine tuned but it will pay huge dividends in sound quality, high speed performance and comfort, especially if you intend using high attenuation earplugs.

When you are convinced that you have fine tuned your speaker positioning to perfection in your first helmet installation, you should now retest the other headset (that's not been installed) and see if you can hear any difference between the installed headset and the one held properly over your ears? It really is worth every minute extra of your time to make the installed headset sound every bit as good as the one held properly over your ears.

When you have completed your first helmet installation you will almost certainly find that it is a lot easier and less time consuming installing and tuning your second helmet. But if it is different or you have any doubts please ask your supplier for advice.

Top Tips (10)

Note you may need to slightly readjust your speakers for more comfort during your first ride out and until they have settled in, or perhaps in time should they slide up in your helmet through putting the helmet on and off.

If passing an approved Autocom dealer you can ask them if you can compare your headset installation with their ear-defender demo/test headsets in the shop. It is a good idea to do this at least once every six months just to check your speakers haven't move over time through putting the helmet on and off.

SETTING THE VOX PRE-SET SENSITIVITY CONTROL READY FOR YOUR FIRST RIDE

Start with the VOX sensitivity preset control set as in picture A (soft/easy/sensitive) and go for a ride to see if the helmet noise at speed can false trigger the VOX. If it does then before adjusting the VOX preset control, first double check that you have blocked the air vents on the inside of the chin-bar of your full face helmet, as this not only prevents wind from blowing directly onto the back of the microphone, it also forces more airflow up into the visor area and so helps with demisting your visor. If using an open face helmet, ensure you have fitted the optional Open Face Conversion Kit (OFCK) Part 2156 properly to the microphone. If these are done and the VOX still false activates when not speaking, please slightly turn the VOX preset control clockwise (about $\frac{1}{8}$ of a turn at a time) and try it again. Keep doing this until you have set the VOX such that helmet noise will not accidentally turn it on at speed when you are not speaking.



If the VOX is hard to operate, first check that you are properly positioning the microphone and using the LOUD-SPOT (If using an open face helmet, ensure you have fitted the Open Face Conversion Kit (OFCK) properly and the right way round to the microphone). If so then please turn the VOX pre-set control $\frac{1}{8}$ th turn anticlockwise (to set the VOX threshold lower) and try again. If required keep doing this until the VOX is easy to speak to, without helmet noise activating it when not speaking.

Top Tips (11)

Use some of the Velcro supplied to block the vents on the inside of the chin-bar of your full face helmet, as this not only prevents wind from blowing directly onto the back of the microphone, it also forces more airflow up into the visor area and so helps with demisting your visor.

WARNING; if the VOX is set too low it will false activate when riding at higher speeds, which will cause the music to keep muting and/or bike to bike transceiver to keep transmitting when not speaking at speed, and this would prevent you from being able to receive bike to bike communications. This is why it is very important to correctly set the VOX and why you must find and use the microphone LOUD SPOT rather than reduce the VOX level to compensate. Remember, not having the master volume controls set any higher than required helps you to naturally speak louder and so operate a higher VOX setting with less effort.

If during your first ride you find that you need to adjust either of the master volume control levels, only make small adjustments at a time and test again.

IMPORTANT POWER OUTPUT WARNING

ONLY use our new 2009 bike to bike interface leads which have a white 9 pin connector (and NO grey din connectors fitted) with this Logic system.

YOU MUST NOT USE our old part 1402 (bike powered Kenwood interface lead) **OR ANY OTHER** bike powered bike to bike radio interface leads that have a **GREY 5 PIN DIN PLUG FITTED** with **ANY OF OUR** new 2009 products.

This is because the old bike powered interface leads (with grey 5 pin din plugs fitted, like part 1402) were designed to work with the 9 volt output of our pre 2009 systems, however **ALL of our NEW 2009 systems now have 12 volt output** for the new and improved bike powered bike to bike interface leads, which now have a better power supply for a wider choice of bike to bike radios, ranging from 4.5 volts, 6 volts, 7.5 volts and 9 volts, each designed to suit specific transceivers.

To help prevent accidental usage (or radio damage) all of the new 2009 products now have an internal white 9 pin Aux 1 connection, which corresponds with the new 2009 bike to bike interface leads.

It is possible to use old NON-POWERED interface leads (which have the grey 5 pin din plug fitted) with the new range of 2009 systems if you first convert your new system to have the old external grey 5 pin din socket fitted using optional part 2356, which has a power WARNING label fitted as this will now have 12 volts output.

Users are **WARNED** that by converting their 2009 system with a grey 5-pin socket, they should not plug-in the old type grey 5-pin plug (bike powered bike-to-bike interface lead) into this connection, **as this will damage the radio by allowing 12 volts into a 9 volt product.**

Don't use old bike-to-bike interface leads with a grey din plug.

Use new interface leads with a white 9 pin connector.

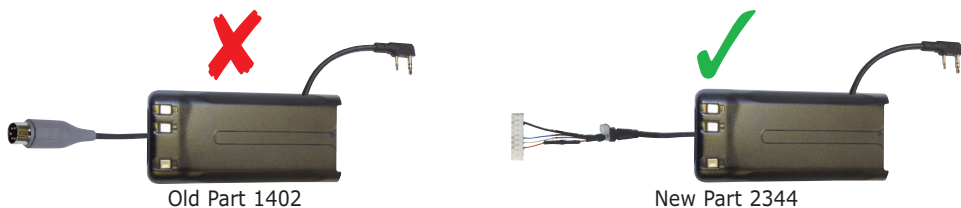

Although it is usually straight forward to connect up and start using bike to bike radios via our VOX systems, **we strongly recommend that your first test and get used to using both radios (hand held) per their own instructions (ensuring that the radios are not in VOX mode) and become familiar with them.** This is important because most typical radios used are half duplex and so you have to get used to taking it in turns speaking to each other, plus allow for any short delays that the radios may have between when you first transmit and start speaking, to when the other radio receives and accepts the transmission, and then allows your transmitted speech to be amplified to the speaker after first accepting the anti-interference tone code. **Using radio discipline (as you would hear professionals use them) greatly improves both the reliability and ease of use.**

This test is also important to prove the radios are set up and able to communicate properly to one another which helps eliminate any frustrating problems that are sometimes caused if the radios are not set up on the same channels or codes etc.

You should always press the press to talk (PTT) button a split second before speaking and always say "OVER" before releasing the PTT button at the end of your communications to let the other person know when you have finished speaking, so that they know they can then speak back. Before the other person speaks back they should always allow a second or so after you have said OVER before pressing their PTT button, and wait a split second before speaking, etc.

When you are practiced and comfortable using the two hand-held radios with some radio discipline, you are then ready to connect one of the radios to the system (using the appropriate interface lead to suit) keeping the other radio as a hand-held for now, while you become practiced in using our VOX in place of the radios PTT. **Please do not try to connect both radios to the systems until you have practiced with one connected and the other as a hand held first.**



CONNECTING A BIKE-TO-BIKE RADIO TO YOUR SYSTEM

Remove the battery cover and batteries (disconnect power lead)
Remove the two Pozi-Drive screws from the back cover (A), and carefully lift it off. This then reveals the white 9 pin AUX connector on the main circuit board (B).

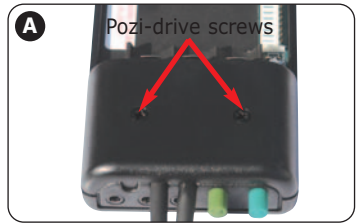

Carefully break off the blanking tab from inside the lid (C), which previously covered the slot in the front panel. Then orientate the interface lead's white connector so that the exposed crimp side of the connector faces forward as per picture (D). Carefully align and press the connector plug into the white 9 pin Aux connector.

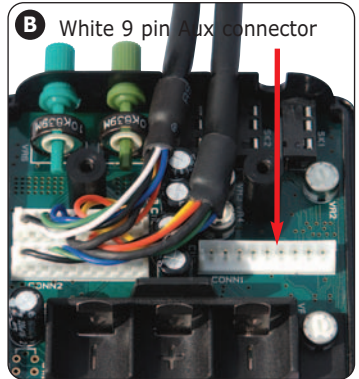

Carefully position the interface lead around the nearby black fixing pillar and push the interface lead into the front panel slot.

Before replacing the lid, push the wires down so that they will not be trapped between the black pillar and lid when it is replaced. With the lid on and in place, check alignment around the front panel etc before replacing the two Pozi-Drive screws (A). refit the batteries (or bike power lead)



Connect the interface leads plug to the radio, making sure it is fully plugged all the way in (fit the retaining clamp if one is provided with the radio) and turn the radio on to about 50% volume (E).

Count to 20 into your microphone and activate your VOX (your own side-tone confirms this for you) the other radio should receive your speech and they can then adjust their hand held radios volume to a suitable level. **Please use this setting as a guide to set the volume on the radio connected to your hub, BEFORE getting the other person to transmit back to you using their hand held radio, and then when they transmit back to you, you can readjust your radios volume if required.**

You will notice two important things happening which you have to understand and get used to working with in order to perfect using the system.

1) When you speak and activate your VOX it instantly switches on (as confirmed by your own side-tone) and the VOX simultaneously switches your bike radio from receive mode (or standby) into transmit mode. (If your radio has a transmit LED or indicator you will notice this activates almost instantly when you speak and operate your VOX).

There is unfortunately a short delay between when this happens and when your speech is actually heard through the other radios speaker. This is because after receiving your transmission, the other radio has to switch between battery saving/standby mode into receive mode and then check and except the anti-interference tone code before allowing the sound to be amplified through the speaker. The result of this short delay is that when you say something like "left at the lights" it may be heard as "at the lights" to which the reply is "what about at the lights", which is heard as "about at the lights", I think you get the message (which is that you won't) so to get over this you must get used to always using a KEY WORD, (like you will hear professionals such as the police use) for example; "OK... turn left at the lights, OVER" this key word and a short pause will ensure that your intended radio transmissions are heard in full, likewise by saying the word OVER allows the other person to know you have ended your communication and after a second or two your VOX will then switch your radio from transmit back to receive, so that they can then speak back to you.

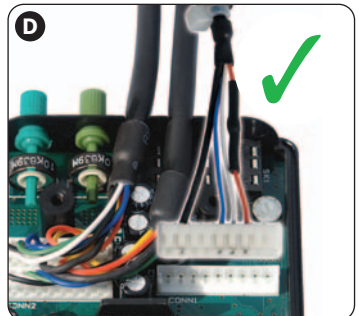

2) When you stop speaking there is a (deliberately designed) short delay before your VOX switches the radio back from transmit mode to receive mode. This delay is the best compromise between; staying on as long as possible to help prevent any pauses during normal conversations causing the system to think you have stopped speaking and returning the radio back to receive mode halfway through your conversations and; as short as possible so that when you do actually stop speaking, the delay time for your radio to stop transmitting and return to receive mode is minimal, so that the other bike/s can then transmit back to you as quickly as possible.



It is often very beneficial to have an experienced third person (with radio) about to monitor your first bike to bike use, so that they can listen for any mistakes either of you make and help guide you with proper use. They will also be able to hear if anyone is transmitting any electrical interference and help identify which bike is the cause, and so help speed up any fault finding processes.

Top Tips (12)

When two metallic objects are struck (or rubbed) together near to a transmitting radio, it can sometimes induce an electrical interference that is transmitted to the receiving radio. If you hear any interference over the bike-to-bike radios, try removing your tool kit from the bike and make sure that your bike drive chain is well lubricated to see if the interference is eliminated. If replacing the tool kit re-introduces the interference, it is a good idea to individually wrap each tool in cling film etc. to stop them rattling together while riding. You may experience a similar problem if you carry a lock and chain under the bikes seat, especially if it is in close proximity to the bike to bike receiver.

INTERNAL CONNECTIONS/SETTINGS/ADJUSTMENTS

Please note; all adjusters are shown as set to factory settings which suit most user's preferences. It is recommended that you consult your dealer before attempting to adjust these internal adjustments.

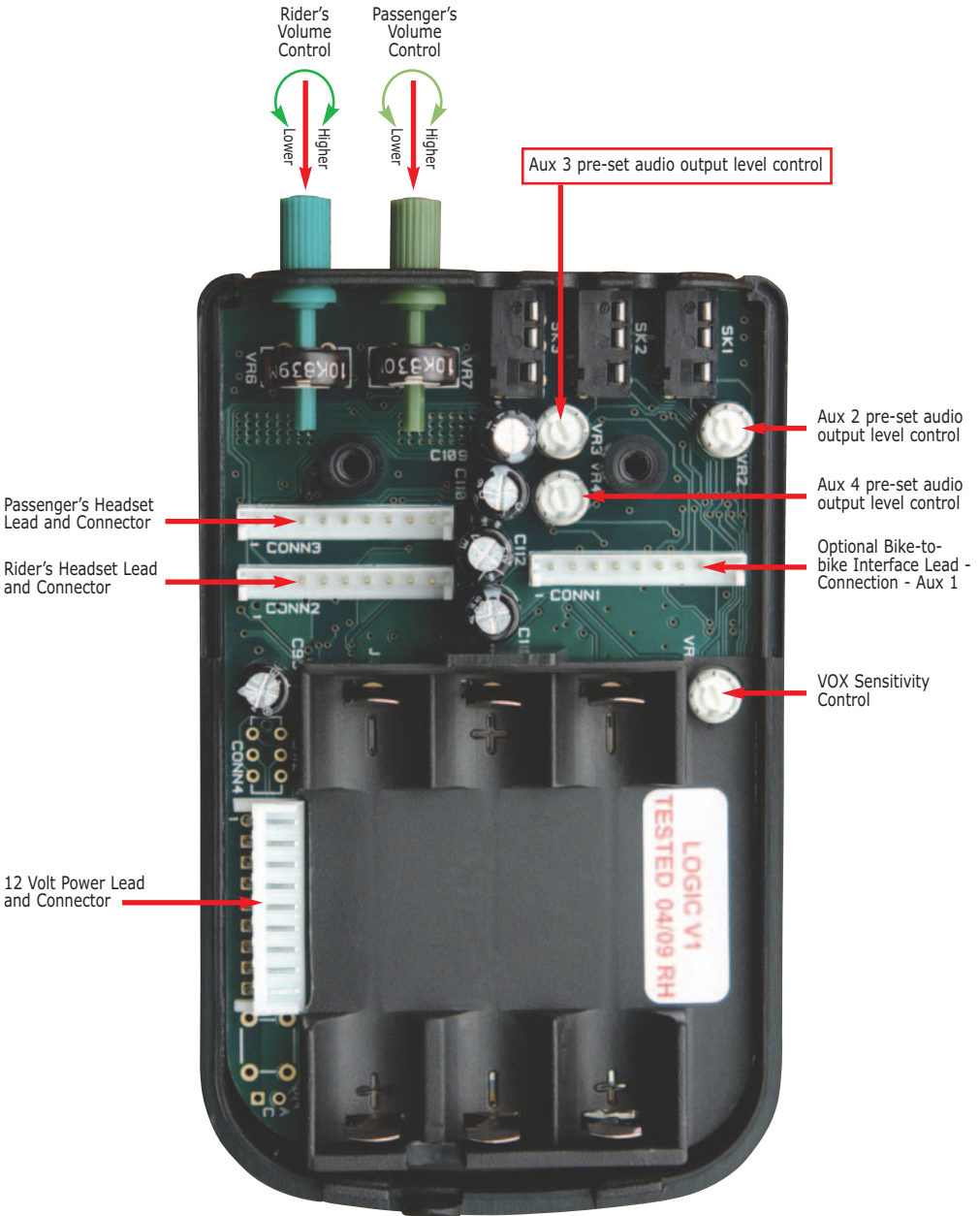

The output level pre-set adjustment controls (**by each audio Aux connection**) affects the audio output level for that Aux connection.

All audio input levels are controlled by the audio devices own volume controls.

Servicing the headset/power leads; as you can see from the above photograph these leads can be unplugged from the main control box and so servicing is easy should you ever damage these leads. If you prefer to swap the rider and passenger headset leads over you can do this but please always position the riders lead in the front panel slot that lines up with the rider identification mark on the lid, as the riders headset with ambient noise sensor must be plugged into the lead that connects to the rider socket inside the main control unit.

Bike-to-bike interface leads; the colours of the wires attached to the white connector may vary.

INSTALLING AND TESTING OPTIONAL AUDIO DEVICES

Always switch the power off (to both the Logic and any audio devices) before unplugging or plugging in any audio leads.

WARNING; YOU MUST NOT USE STANDARD WIRED INTERFACE LEADS between two bike powered audio devices. Your Super Pro Automatic is bike powered and so you can only use standard wired audio interface leads to connect with portable audio devices that are powered by their own (independent and so isolated) batteries.

IF YOUR AUDIO DEVICE IS BIKE POWERED YOU MUST USE SPECIAL ISOLATED INTERFACE LEADS.

Always turn the power off before connecting or disconnecting any audio lead.

If you use a standard wired interface lead between a bike powered Autocom system and a bike powered audio device you will cause earth loops (or ground/negative loops) which will cause undesirable noise and in many cases also cause your audio devices independent earth audio output amplifier to short and over-heat, which could result in a damage to the audio devices, or fire.

If using a wireless Bluetooth device then you do not need to worry about isolation, as they are isolated (wireless).

Please consult your authorised Autocom dealer or see our website www.autocom.co.uk for more information.

While installing and testing audio interface leads/devices, connect one audio lead/device at a time, then start the engine and test/check that the audio is clear of any electrical interference before installing the next lead/device. If you hear any electrical noise introduced during this installation/testing process, you will know which lead/device is causing the problem and so can move it to a noise free location before continuing. As with installing/testing the main control hub and headset leads avoid problem areas such as high heat from the engine or exhaust and spark plugs/HT leads/coils etc as mentioned on (page 6).

Aux 1 is the internal 9 pin white connector designed for bike to bike radios, with a mono input (that is amplified to both rider and passenger's left and right speakers) mono output of both rider and passenger noise cancelled speech, plus VOX switching for hands free bike to bike use. If the Logic hub is bike powered Aux 1 also provides 12 volts output to bike power recommended transceivers via a special interface lead.

Aux 2, 3, 4, 5 and 6 are all stereo inputs plus mono noise cancelled speech outputs. The way in which each Aux input is affected by others, or affects other inputs is detail on page 3.

Remember it is important that you set each users master volume control to suit each users own level of side-tone and then fine tune the levels as required to suit the received speech from the other user. If any other audio levels (such as bike to bike, phone GPS or music etc) need to be adjusted it is important that you adjust each level using the audio devices own volume control. Do not turn the master volume controls up or down to adjust other audio input levels, as doing so may unbalance your desired level of side-tone or that of the other user's speech level. Once everything is set up and balanced you will normally only ever use the master volume control/s to suit individual needs or differences between using earplugs or not.

Some popular audio interface leads which may be of interest

Part 2253 **Mono Isolation Lead** with 3.5mm 4 pole input socket and 3.5mm 4 pole plug to Logic Aux 2, 3 or 4.

Part 2254 **Stereo Isolation Lead** with 3.5mm 4 pole input socket and 3.5mm 4 pole plug to Logic Aux 2, 3 or 4.

Part 2255 **Twin Input (Mixed) Stereo Isolation Lead** with two 3.5mm 4 pole input sockets and 3.5mm 4 pole plug to Logic Aux 2, 3 or 4. Please use the above isolation leads with your choice of Parts 2240 to 2251).

Part 2190 **Stereo Input, Mono Output Isolation Lead** (for Zumo 500/550/660 with phone) with 3.5mm 4 pole input socket and 3.5mm 4 pole output socket, for use with Parts 2245 and 2248) and has a 3.5mm 4 pole plug to Logic Aux 2 or 3.

Part 2217 Single stereo wireless Bluetooth module (plugs into PORTABLE Logic Aux 5 internal).

Part 2218 Twin stereo wireless Bluetooth module (plugs into PORTABLE Logic Aux 5 and 6 (internal)).

Part 2221 Remote extension lead and housing for Part 2217 or 1118 **if the Logic is bike mounted.**

Please note Parts 2217 an 2218 come with a replacement label and new higher profile raised lid and longer screws.

To fit part 2217 or 2218 please remove all batteries or bike power lead before installing.

Ask your Autocom dealer, or visit our website www.autocom.co.uk about various isolated and non-isolated optional parts.

TROUBLESHOOTING GUIDE

Speech volume is too quiet.

- Only adjust the riders or passengers volume controls to increase volume levels after you have first checked you have correctly positioned the speakers and are talking into the beige side of the microphone and using the microphone loud spot, if required raise your voice.

Phone/GPS/radar/transceiver or music volume is too quiet.

- Ensure speakers are correctly positioned (remember speakers may slip up over time).
- Adjust volume level on each audio device such as phone/GPS etc to suit.
- Only adjust the master volume control/s to increase the overall volume levels.

Music mutes 50% even when I don't speak.

- Increase the VOX level by turning the control anti-clockwise.

Phone will not auto answer.

- Ensure your phone has this facility.
- Ensure that you have connected the adaptor block properly (if needed).
- Check that the phone is set to auto-answer whilst in headset mode (hands free).
- Try connecting the adaptor to the phone followed by plugging the lead in.

Problems with bike-to-bike radios

- Ensure that you take turns to speak and that you leave 2 seconds between transmissions. See pages 14/15 for tips.
- Ensure both transceivers are on the same channel and sub-tone.
- Check that the connections on the radio are secure.
- Adjust volume level on each transceiver.
- Ensure the microphone is positioned correctly and that you are using the loud spot and operating the VOX see page 6.
- If using a press-to-talk (PTT) check the switch position is set to VOX mode.
- Ensure tool kits are removed or individually wrap each tool in cling film.

Interference whilst the engine is running.

- If you are bike powering your system and any audio devices connected by wire, check that you are using isolated interface leads. Unplug all accessories and see if the noise is still audible. If the noise has gone, plug one lead in at a time until the noise returns. You now know which lead is picking up the noise. It will either need re-routing or it is an incorrect lead.

If you need more help or advice please contact your local Autocom supplier.

STANDARD 12 MONTHS MANUFACTURERS WARRANTY

If your supplier has not given advice or demonstration on how to set up or use our products, please check with them before sending any goods back for warranty.

All Autocom products are warranted for a period of 12 months from the date of original purchase, to the original purchaser, from an authorised Autocom retailer. This warranty covers faulty materials or workmanship, subject to the goods being used only as stated, and only for the purpose as described in the instruction manuals.

No manufacturer's warranty applies to the goods where they are used for any other purpose or in any other way than is explained in the instructions. Nor where the goods have been subjected to misuse, neglect or accidental damage, or used with any other vendor's products, including incorrect mechanical or electrical installation, or where the goods have been repaired, modified or altered, without the manufacturer's written authorisation.

The manufacturer's warranty is limited to the goods being returned pre paid to the manufacturer's factory, with the original packaging and the original proof of purchase date. The goods must be intact for our examination.

This warranty does not cover any consumable items such as batteries, replaceable hygiene foam coverings for speakers and microphones, or any other items that are described within the instruction manuals as being a consumable.

Where goods are accepted by the manufacturer, under the terms of the warranty, they will be repaired free of charge or replaced (at the option of the manufacturer). Where the goods are returned as faulty and are found not to be, a charge will be payable to cover costs of inspection, testing, packing and return postage. For details of authorised repair centers available in various countries please ask your dealer or visit www.autocom.co.uk

The manufacturer's warranty does not affect your statutory rights.

FOR ANY FURTHER HELP OR INFORMATION PLEASE CONTACT YOUR SUPPLIER OR

Autocom Products Limited

Unit 4, Tachbrook Link, Tachbrook Park Drive, Warwick, CV34 6RH. England
Telephone: +44 (0)1926 431249 (10 lines) - Fax: +44 (0)1926 431250
Email: enquiries@autocom.co.uk - Website: www.autocom.co.uk



PRODUCT REGISTRATION

Dear customer, **PLEASE REGISTER YOUR NEW PRODUCTS** within 30 days of purchase and **receive priority service**, simply by returning this completed form to:

Autocom Products Limited

Unit 4, Tachbrook Link, Tachbrook Park Drive, Warwick, CV34 6RH. England.

or

fill in a product registration form on-line at; www.autocom.co.uk

CUSTOMER DETAILS

Original purchase date:

Name:

Address:

.....

.....

Post code/Zip code:Country:.....

Telephone:

Email:

Please confirm; **I do / do not** wish to receive additional/updated information about your products, and/or other new products which may be of interest to you.

Privacy

There is no legal obligation on your part to provide the personal information requested, however such information allows us to maintain a record about the products and how customers are supplied and supported, which can help improve our standards and speed up any returns/service works. The information collected will be used for marketing purposes by Autocom and our authorised distributors only. We may contact you either in relation to the products you already have or other Autocom products which may be of interest to you.

SUPPLIERS DETAILS (please stamp if available)

Original purchase date:

Dealers Name:

Address:

.....

.....

Post code/Zip code:Country:.....

Telephone:

Email:

Member of staff who sold the products (optional).....

Product serial number

(visible in the battery compartment)

Kit L-1



AUTOCOM[®]
Specialist Communications
www.autocom.co.uk

Unit 4, Tachbrook Link,
Tachbrook Park Drive, Warwick CV34 6RH. England
Tel: +44 (0)1926 431249 • Fax: +44 (0)1926 431250
Email: enquiries@autocom.co.uk
Website: www.autocom.co.uk

